

**POGONI ZA  
ZAPORNE ZAKLOPKE**

**RUČNI PUŽNI POGON ZA ZAKLOPKE**

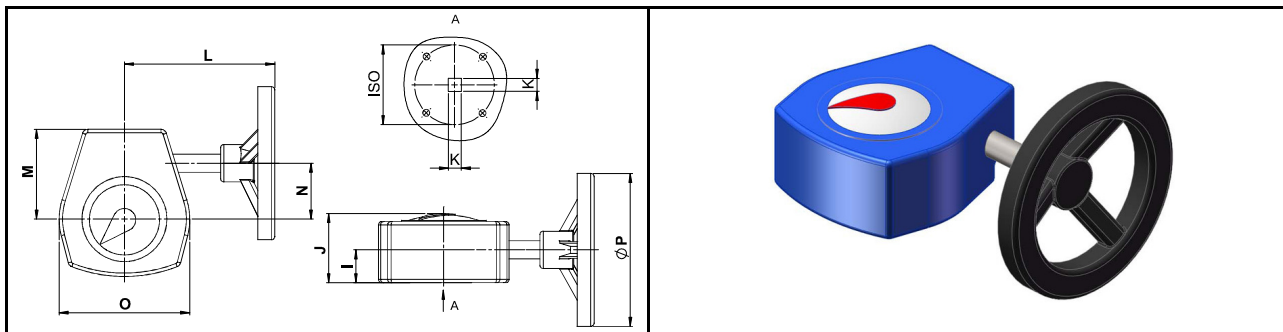



**Materijali**



Kučište	Sivi lijev – GG25
Kolo	Aluminij



Kat. Broj	DN	I	J	L	M	N	O	ØP	ISO	K	Težina
A031498	40–100	28	67	135	77	45	118	135	F7	K11	2,00
A031499	125–150	33	78	220	110	75	170	210	F7	K14	5,00
A031500	200	33	78	220	110	75	170	210	F10	K17	5,00
A031501	250–300	33	78	220	110	75	170	210	F10	K22	5,00

# POGONI ZA ZAPORNE ZAKLOPKE

## ELEKTROMOTORNI POGON

ZAPORNA ZAKLOPKA DN	ER RANGE & V ECONOMICAL (ER/VS)									
	Kat. Broj	Oznaka pogona	Prirubnica ISO	Nastavak K	Moment (Nm)	Isprekidanost (%)	Snaga (W)	Vrijeme otvaranja (s)	Težina (kg)	
	40	A037855	ER20.X0A.G00	F03-F05	14	10	50	15	12	1,50
	50	A037855	ER20.X0A.G00	F03-F05	14	10	50	15	12	1,50
	65	A038578	ER35.90A.G00	F03-F05	22	35	50	45	7	1,50
	80	A037857	ER60.90A.G00	F05-F07	22	60	50	45	12	3,00
	100	A037858	ER100.90A.G00	F05-F07	22	100	50	45	23	3,00
	125	A037844	VS150.90A.M00	F07-F10	22	150	30	45	30	5,60
	150	A037844	VS150.90A.M00	F07-F10	22	150	30	45	30	5,60
	200	A037842	VS300.90A.M00	F07-F10	22	300	30	85	30	5,60

ZAPORNA ZAKLOPKA DN	V RANGE (VR/VS/VT)									
	Kat. Broj	Oznaka pogona	Prirubnica ISO	Nastavak K	Moment (Nm)	Isprekidanost (%)	Snaga (W)	Vrijeme otvaranja (s)	Težina (kg)	
	40	A037859	VR25.70A.G00	F05-F07	17	16	50	45	7	3,10
	50	A037859	VR25.70A.G00	F05-F07	17	20	50	45	7	3,10
	65	A037840	VR45.70A.G00	F05-F07	17	45	50	45	15	3,10
	80	A037840	VR45.70A.G00	F05-F07	17	45	50	45	15	3,10
	100	A037848	VR75.70A.G00	F05-F07	17	75	50	45	20	3,10
	125	A037072	VS150.90A.G00	F07-F10	22	150	50	85	30	5,60
	150	A037072	VS150.90A.G00	F07-F10	22	150	50	85	30	5,60
	200	A037850	VS300.90A.G00	F07-F10	22	300	50	85	50	5,60
	250	A037851	VT600.A08.T00	F10-F12	36	600	50	250	38	17,10
	300	A037851	VT600.A08.T00	F10-F12	36	600	50	250	38	17,10

ZAP. ZAKLOPKA DN	ATEX (VRX/VSX)									
	Kat. Broj	Oznaka pogona	Prirubnica ISO	Nastavak K	Moment (Nm)	Isprekidanost (%)	Snaga (W)	Vrijeme otvaranja (s)	Težina (kg)	
	40	A037860	VRX25.70A.G00	F05-F07	17	25	50	45	7	4,00
	50	A037860	VRX25.70A.G00	F05-F07	17	25	50	45	7	4,00
	65	A037853	VRX45.70A.G00	F05-F07	17	45	50	45	15	4,00
	80	A037853	VRX45.70A.G00	F05-F07	17	45	50	45	15	4,00
	100	A037854	VRX75.70A.G00	F05-F07	17	75	50	45	20	4,00
	125	A037861	VSX150.90A.G00	F07-F10	22	150	50	85	30	6,50
	150	A037861	VSX150.90A.G00	F07-F10	22	150	50	85	30	6,50
	200	A037863	VSX300.90A.G00	F07-F10	22	300	50	85	50	6,50

## PNEUMATSKI POGON

ZAPORNA ZAKLOPKA DN	DVOSTRANO DJELOVANJE (UT)						
	Kat. Broj	Oznaka pogona	Prirubnica ISO	Nastavak K	Moment (Nm) P=6 bar	Težina (kg)	
	40	A039358	UT15	F05	14	33	1,83
	50	A039358	UT15	F05	14	33	1,83
	65	A039352	UT17	F05	14	44	2,35
	80	A039359	UT20	F07	17	60	2,87
	100	A039353	UT25	F07	17	91	4,00
	125	A039360	UT35	F10	22	193	7,58
	150	A039360	UT35	F10	22	193	7,58
	200	A039362	UT45	F10	22	377	12,46
	250	A039363	UT50	F12	27	544	17,80
	300	A039365	UT60	F14	36	1099	36,30

ZAPORNA ZAKLOPKA DN	JEDNOSTRANO DJELOVANJE (UT)						
	Kat. Broj	Oznaka pogona	Prirubnica ISO	Nastavak K	Moment (Nm)	Težina (kg)	
	40	A039366	UT20-SR4	F07	17	21	3,25
	50	A039367	UT25-SR4	F07	17	28	4,52
	65	A039368	UT25-SR5	F07	17	35	4,52
	80	A039370	UT30-SR5	F07	17	53	5,57
	100	A039372	UT35-SR5	F10	22	87	9,02
	125	A039373	UT45-SR4	F10	22	126	15,02
	150	A039375	UT50-SR4	F12	27	196	22,63
	200	A039376	UT60-SR4	F14	36	386	45,90
	250	A039378	UT65-SR5	F14	36	588	52,40